

# Happy D.2 Plus

# # HP 4740

## Notice de montage

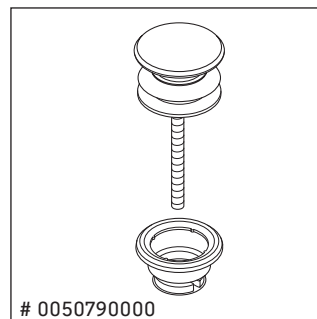
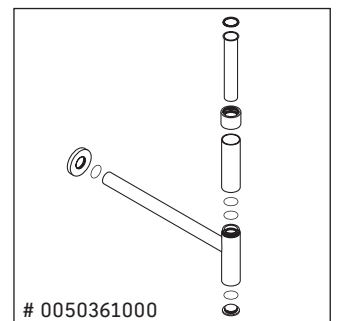
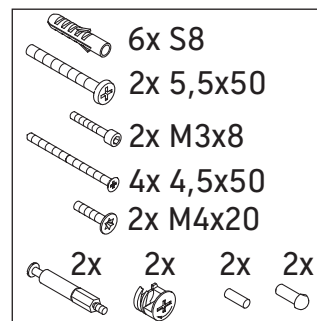
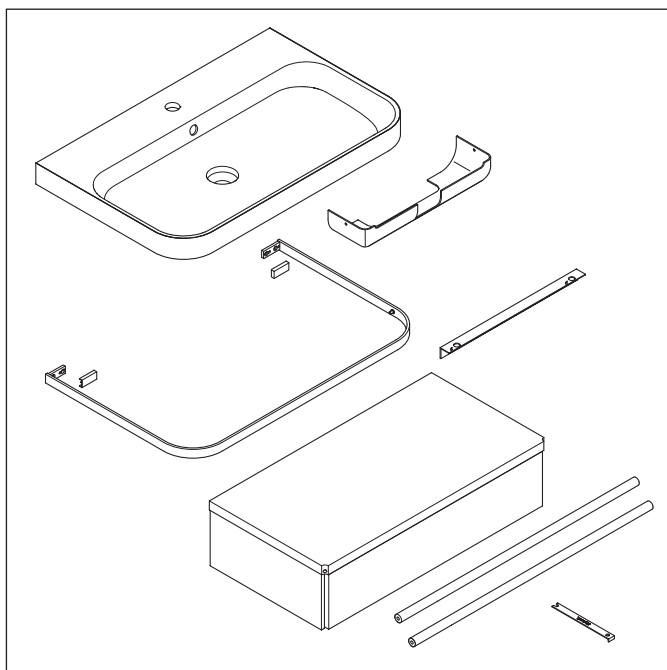
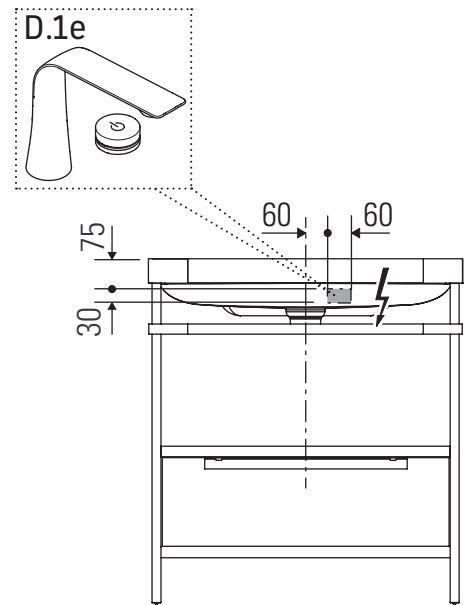
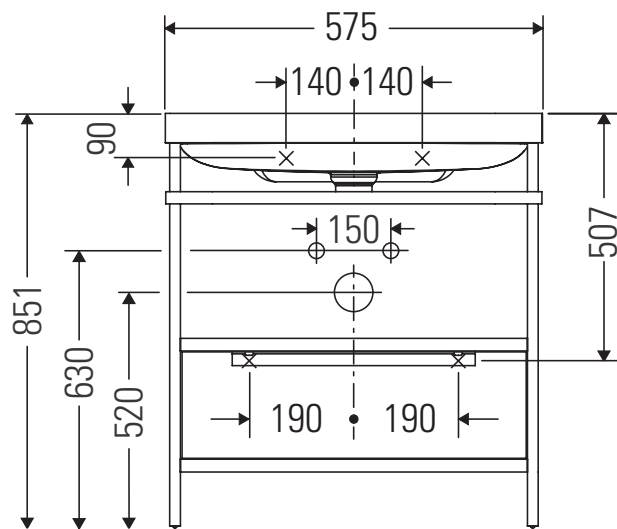

## Consignes d'utilisation

La série de meubles de salle de bain est conforme aux normes et directives en vigueur au moment de la livraison et a été conçue pour une utilisation dans les salles de bain. Éviter tout mouillage avec de l'eau, par ex. lors de la douche.

Nous nous réservons le droit d'apporter des améliorations techniques ou des modifications externes aux produits présentés.

